



ETA-Danmark A/S
Göteborg Plads 1
DK-2150 Nordhavn
Tel. +45 72 24 59 00
Internet www.etadanmark.dk

Authorised and notified
according to Article 29 of the
Regulation (EU)
No 305/2011 of the European
Parliament and of the Council
of 9 March 2011

MEMBER OF EOTA



European Technical Assessment ETA-20/1125 of 2020/12/15

I General Part

Technical Assessment Body issuing the ETA and designated according to Article 29 of the Regulation (EU) No 305/2011: ETA-Danmark A/S

Trade name of the construction product:

FIREPRO® Intumescent Pipe Wrap

Product family to which the above construction product belongs:

Fire Stopping, Fire Sealing & Fire Protective Products.
Fire Retardant Products

Manufacturer:

ROCKWOOL Ltd
Wern Tarw
Pencoed
Bridgend
South Wales
CF35 6NY

Manufacturing plant:

E/055

This European Technical Assessment contains:

20 pages including 1 annex which form an integral part of the document

This European Technical Assessment is issued in accordance with Regulation (EU) No 305/2011, on the basis of:

EAD 350454-00-1104 Fire Stopping and Fire Sealing Products-Penetration Seals: Issue September 2017

This version replaces:

-

Translations of this European Technical Assessment in other languages shall fully correspond to the original issued document and should be identified as such.

Communication of this European Technical Assessment, including transmission by electronic means, shall be in full [except the confidential Annex(es) referred to above]. However, partial reproduction may be made with the written consent of the issuing Technical Assessment Body. Any partial reproduction has to be identified as such.

1. Technical Description of the Product

- 1) FIREPRO® Intumescent Pipe Wrap is installed around combustible pipes to form a penetration seal used to reinstate the fire resistance performance of wall and floor constructions, where they have been provided with apertures for the penetration of combustible pipe services.
- 2) FIREPRO® Intumescent Pipe Wrap are supplied in assembled form. The intumescent in the wrap is contained within a lightweight PVC carrier bag and is installed around the pipe at the soffit and upper face of floors, and both faces of walls, depending on application. Fixing specifications are provided in Annex A.
- 3) FIREPRO® Intumescent Pipe Wrap can be used with FIREPRO® Acoustic Intumescent Sealant to seal the space between the combustible pipe and the aperture to close gap sizes as specified in Annex A.

2. Specification Of The Intended Use In Accordance With The applicable European Assessment Document (EAD)

- 1) The intended use of FIREPRO® Intumescent Pipe Wrap is to reinstate the fire resistance performance of wall and floor constructions, where they are penetrated by various combustible pipe services.

The specific elements of construction that the FIREPRO® Intumescent Pipe Wrap may be used is as follows:

- Flexible walls: The wall must have a minimum thickness of 100 mm and comprise timber or steel studs line on both faces with minimum 2 layers of 12.5 mm thick, 'Type F' Gypsum boards according to EN 520. In timber stud walls, no part of the penetration seal shall be closer than 100mm to a stud, and minimum 100 mm of insulation of class A1 or A2 according to EN 13501-1, is provided within the cavity between the penetration seal and the stud.
- Rigid walls: The wall must have a minimum thickness of 100 mm and comprise of concrete, aerated concrete or masonry, with a minimum density of 650 km/m³.
- Rigid floor: The floor must have a minimum thickness of 150 mm and comprise of concrete, aerated concrete or masonry, with a minimum density of 650 km/m³.

- 2) The supporting construction must be classified in accordance with EN 13501-2 for the required fire resistance period.
- 3) The FIREPRO® Intumescent Pipe Wrap may be used to provide a penetration seal with specific combustible pipes, single only (for details see Annex A).
- 4) Apertures in the separating element shall be maximum oversize with respect to the pipe diameter according to the tables listed in Annex A. The remaining annular space/gap shall be infilled with FIREPRO® Intumescent Pipe Wrap. Apertures for the penetration of pipes shall be separated by a minimum of 200 mm.
- 5) The provisions made in this European Technical Assessment are based on an assumed working life of the FIREPRO® Intumescent Pipe Wrap of 10 years, The indications given on the working life cannot be interpreted as a guarantee given by the producer or the Technical Assessment Body, but are to be regarded only as a means for choosing the right products in relation to the expected economically reasonable working life of the works.
- 6) Services in walls shall be supported at maximum 400mm from the face of the separating element for walls, and 400mm above the surface of the floor.

2.1 Use Category

Type X: Intended for use in conditions exposed to weathering.

3. Performance Of The Product And References To The Methods Used For Its Assessment

	Characteristic	Assessment of characteristic
BWR 1 Mechanical resistance and stability		
BWR 2 Safety in case of fire		
	Reaction to fire	See Clause 3.1.1
	Resistance to fire	See clause 3.1.2
BWR 3 Hygiene, Health and the Environment		
	Release of dangerous substances	See clause 3.2.1
BWR 4 Safety in use		
	Durability and serviceability	See Clause 3.3.1

3.1 Safety in case of fire

3.1.1 Reaction to fire

FIREPRO® Intumescent Pipe Wrap is classified **E** in accordance with EN 13501-1

3.1.2 Resistance to fire

See Annex A

3.2 Hygiene, Health and the Environment

3.2.1 Release of dangerous substance

Category IA1, S/W3 Declaration of manufacturer

ROCKWOOL Ltd have presented a declaration that FIREPRO® Intumescent Pipe Wrap releases no dangerous substances in compliance with Council Directive 67/548/EEC of 1st June 2015 on the approximation of the laws, regulations and administrative provisions of the Member States relating to restrictions on the marketing and use of certain dangerous substances and preparations (incl. All amendments and adaptations).

The manufacturer declares that the product contains no dangerous substances according to current European and National regulations.

ROCKWOOL Ltd has submitted a written declaration that the product and/or constituents of the product contains no substances which have been classified as dangerous according to Directive 67/548/EEC and Regulation (EC) No. 1272/2008 and listed in the 'indicative list on dangerous substances' of the EGDS – taking into account the installation conditions of the construction product and the release scenarios resulting from there.

In addition to the specific clauses relating to dangerous substances contained in this European Technical Assessment, there may be other requirements applicable to the products falling within its scope (e.g. transposed European legislation and national laws, regulations and administrative

provisions). In order to meet the provisions of the Construction Products Regulation, these requirements need also to be complied with, when and where they apply.

The use category of FIREPRO® Intumescent Pipe Wrap in relation to BWR 3 (Hygiene, health and environment) is IA1, S/W3.

3.3 Safety in use

3.3.1 Durability and serviceability

FIREPRO® Intumescent Pipe Wrap has been tested in accordance with EOTA Technical Report - TR024 – Edition November 2006, for the type X, environmental conditions: Products for penetration seals intended for outdoor use exposed to weathering – rain, UV, high temperatures, frost and frost-thaw in winter.

4. Assessment And Verification Of Constancy Of Performance (Hereinafter AVCP) System Applied, With References To Its Legal base

According to the decision 1999/454/EC of the European Commission the system of assessment and verification of constancy of performance (see Annex V to the Regulation (EU) No 305/2011) given in the following table apply:

Products	Intended use/s	AVCP System
Fire stopping and fire sealing products	For fire compartmentation and / or fire protection or fire performance	System 1

5 Technical Details Necessary For The Implementation Of The AVCP System, As Provided For In The Applicable EAD.

Technical details necessary for the implementation of the AVCP system are laid down in the control plan deposited at ETA-Danmark A/S prior to CE marking

Issued in Copenhagen on 2020-12-15 by



Thomas Bruun
Managing Director, ETA-Danmark

Annex A

Resistance to Fire Classification of FIREPRO® Intumescent Pipe Wrap

A.1 Intumescent Thickness

The permitted thickness of the intumescent material for various ranges of pipe diameters:

Intumescent Thickness	
Pipe Diameter	Intumescent Material
ø 32 mm - ø 50 mm	40 mm (W) x 2 mm (T)
ø 51 mm - ø 82 mm	40 mm (W) x 4 mm (T)
ø 83 mm - ø 115 mm	40 mm (W) x 6 mm (T)
ø 116 mm - ø 160 mm	40 mm (W) x 8 mm (T)
ø 161 mm - ø 200 mm	40 mm (W) x 10 mm (T)
ø 201 mm - ø 250 mm	40 mm (W) x 12 mm (T)

A.2 Floor construction with thickness of minimum 150 mm

A.2.1 Penetration seal with FIREPRO® Intumescent Pipe Wrap installed within both sides of rigid floor

Construction details: Combustible pipes installed with a single FIREPRO® Intumescent Pipe Wrap within both sides. Maximum annular space according to the tables listed in A.2.1.1 to A.2.1.3 filled with FIREPRO® Acoustic Intumescent Sealant.

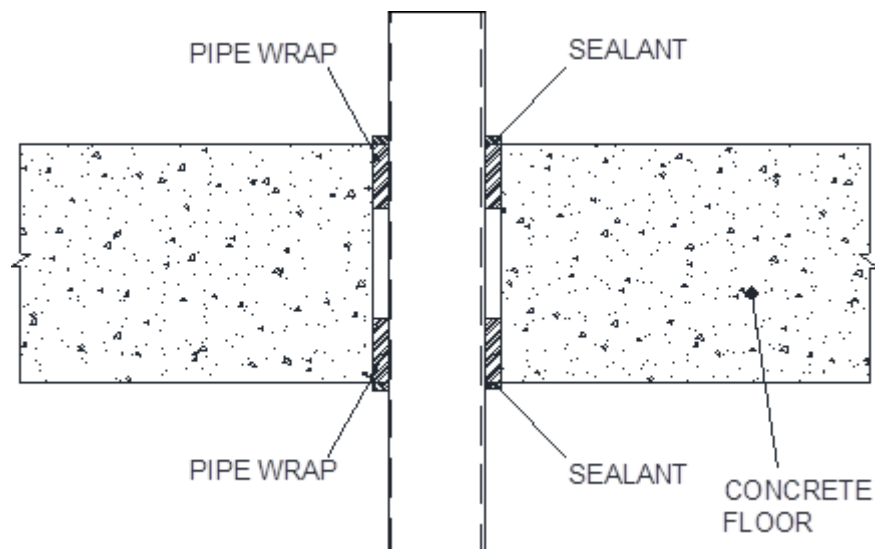

A.2.1.1 PVC-U pipes with FIREPRO® Intumescent Pipe Wrap installed within both sides of rigid floor

PVC pipes according to EN 1452 with FIREPRO® Intumescent Pipe Wrap.

FIREPRO® Intumescent Pipe Wrap, Friction Fitted Flush to Both Sides of Rigid Floor (min 150 mm thick) PVC Pipes				
Penetration Specification	Wrap Reference	Intumescent Material	Annulus Space (mm)	Classification
PVC Pipe 32 mm ϕ 1.8 mm wall thickness	32 mm FIREPRO® Intumescent Pipe Wrap	40 mm (W) x 2 mm (T)	4	EI 120 U/C
PVC Pipe 40 mm ϕ 1.8 mm wall thickness	40 mm FIREPRO® Intumescent Pipe Wrap			
PVC Pipe 50 mm ϕ 1.8 mm wall thickness	50 mm FIREPRO® Intumescent Pipe Wrap			
PVC Pipe 200 mm ϕ 7.7 mm wall thickness	200 mm FIREPRO® Intumescent Pipe Wrap	40 mm (W) x 10 mm (T)	12	E120 U/C EI90U/C
PVC Pipe 200 mm ϕ 9.6 mm wall thickness	200 mm FIREPRO® Intumescent Pipe Wrap			EI 60 U/C

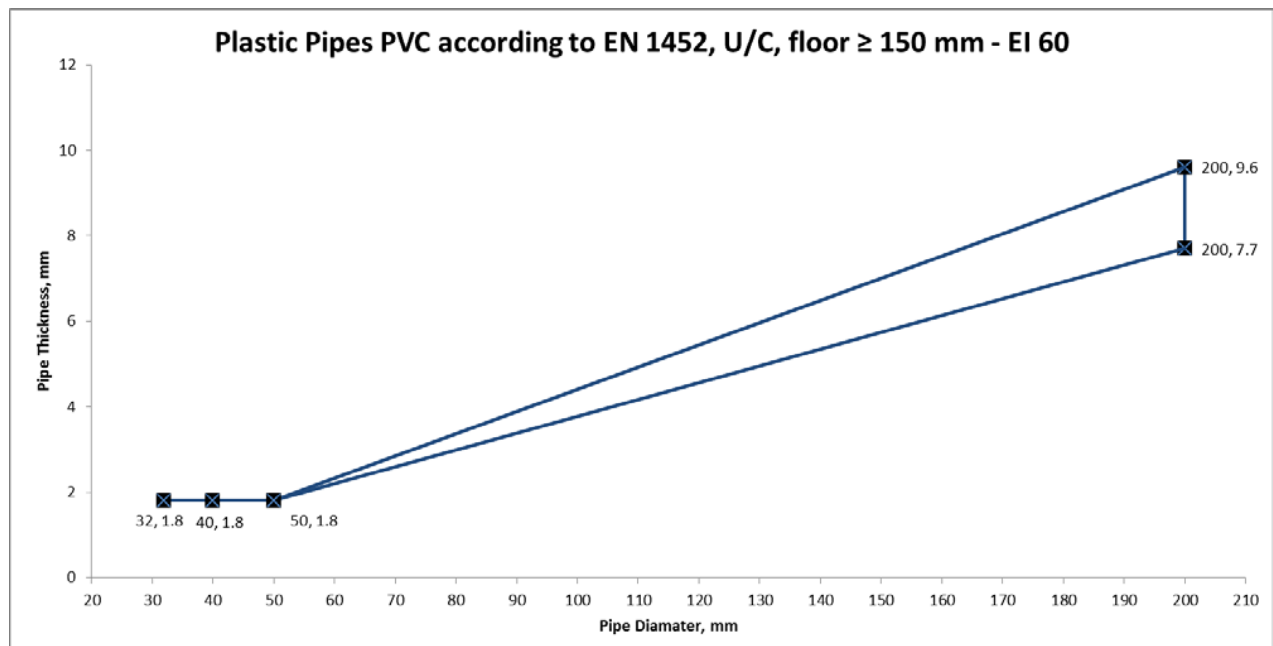

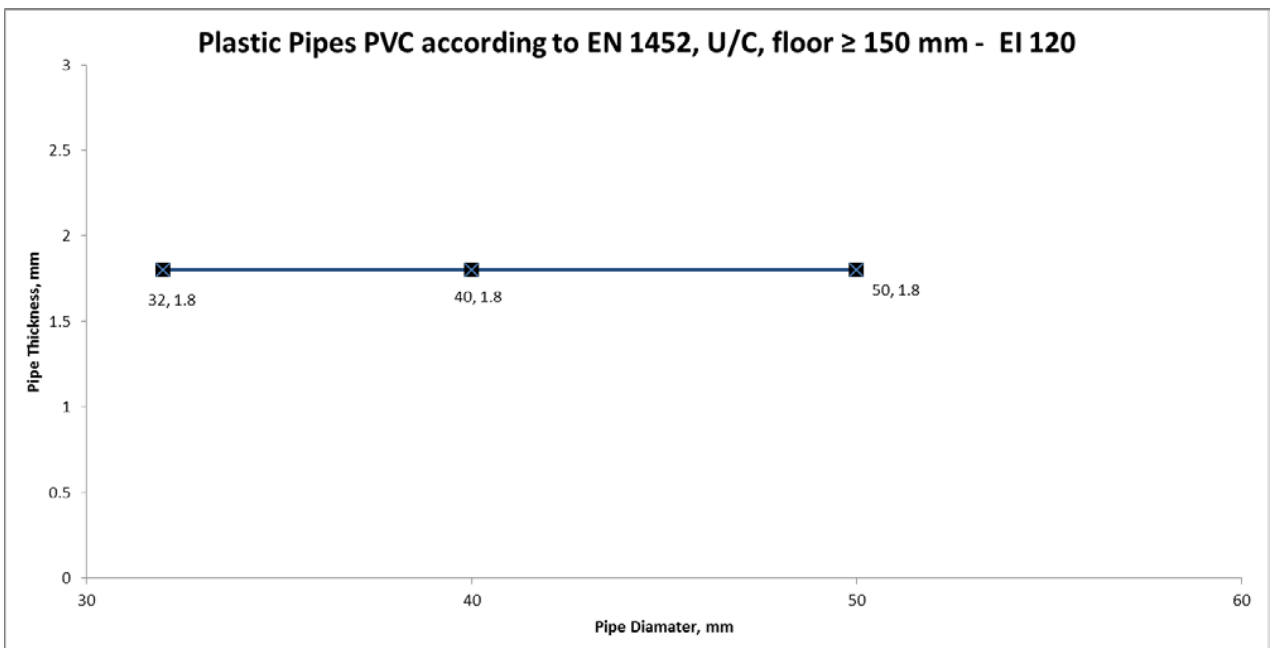
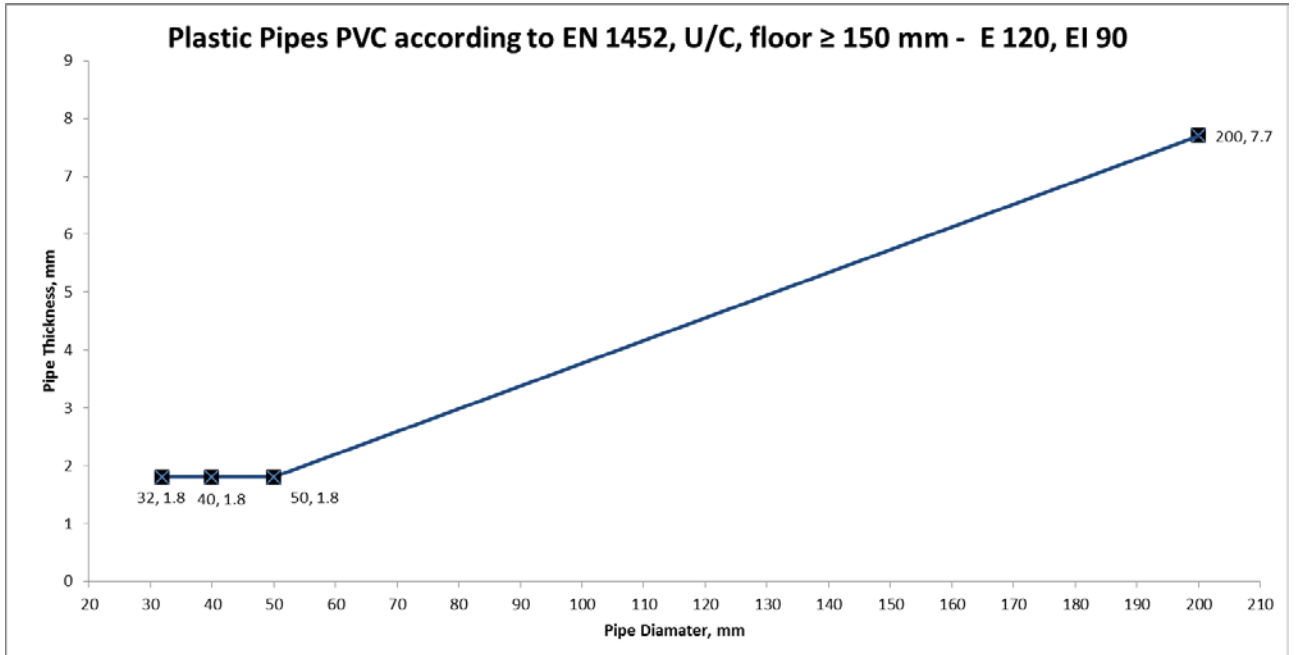

A.2.1.2 PP pipes with FIREPRO® Intumescent Pipe Wrap installed within both sides of rigid floor

PP pipes according to EN 1451 with FIREPRO® Intumescent Pipe Wrap.

FIREPRO® Intumescent Pipe Wrap, Friction Fitted Flush to Both Sides of Rigid Floor (min 150 mm thick) PP Pipes				
Penetration Specification	Wrap Reference	Intumescent Material	Annulus Space (mm)	Classification
PP Pipe 32 mm \varnothing 2.9 mm wall thickness	32 mm FIREPRO® Intumescent Pipe Wrap	40 mm (W) x 2 mm (T)	4	EI 120 U/C
PP Pipe 40 mm \varnothing 2.9 mm wall thickness	40 mm FIREPRO® Intumescent Pipe Wrap			
PP Pipe 50 mm \varnothing 2.9 mm wall thickness	50 mm FIREPRO® Intumescent Pipe Wrap			
PP Pipe 200 mm \varnothing 4.9 mm wall thickness	200 mm FIREPRO® Intumescent Pipe Wrap	40 mm (W) x 10 mm (T)	12	E 20 U/C EI 15 U/C
PP Pipe 200 mm \varnothing 18.2 mm wall thickness	200 mm FIREPRO® Intumescent Pipe Wrap			E 120 U/C EI 90 U/C

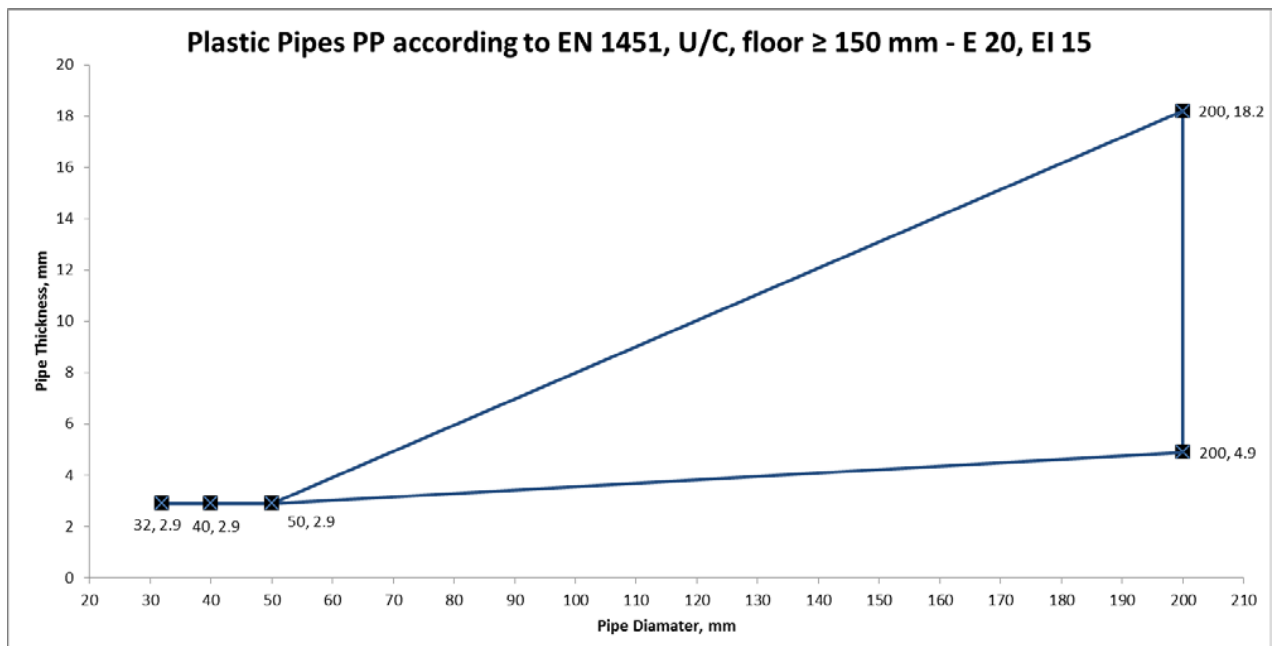

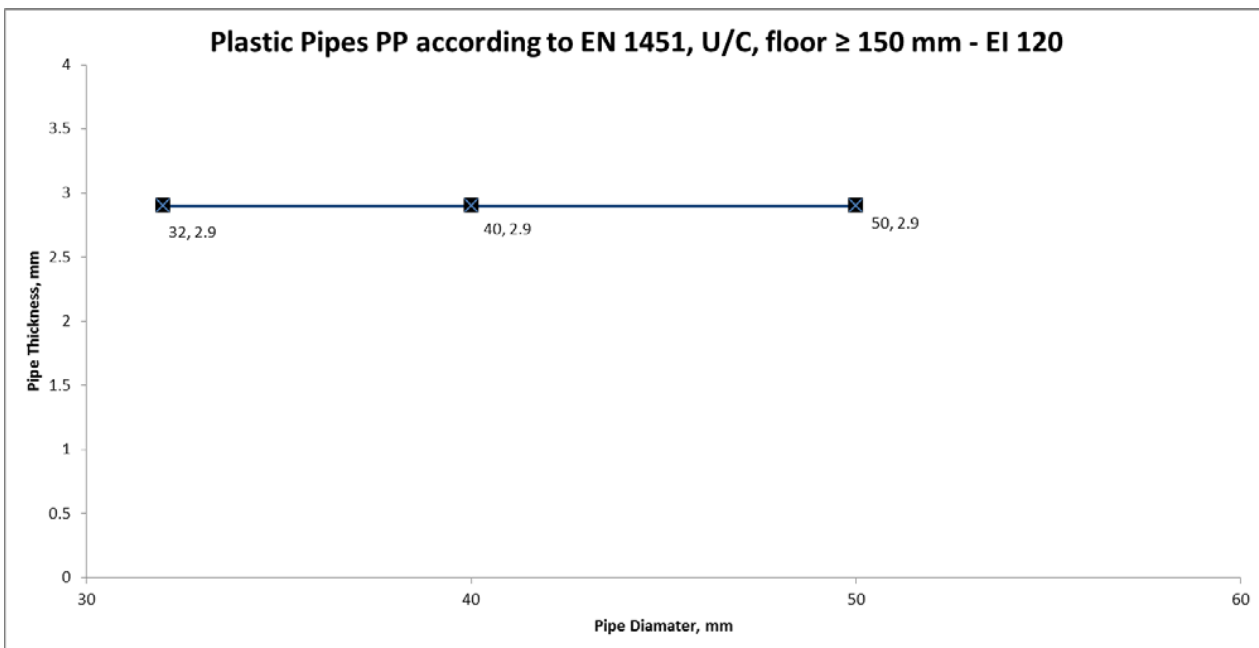
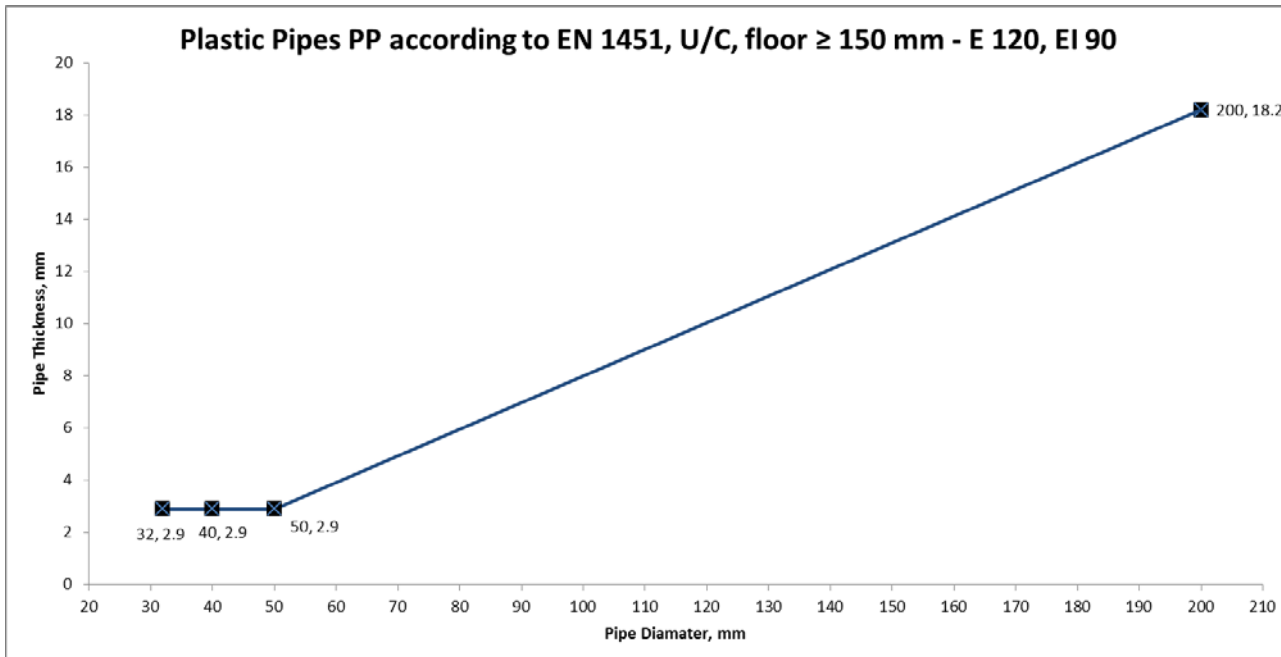

A.2.1.3 HDPE pipes with FIREPRO® Intumescent Pipe Wrap installed within both sides of rigid floor

HDPE pipes according to EN 1519 with FIREPRO® Intumescent Pipe Wrap.

FIREPRO® Intumescent Pipe Wrap, Friction Fitted Flush to Both Sides of Rigid Floor (min 150 mm thick) HDPE Pipes				
Penetration Specification	Wrap Reference	Intumescent Material	Annulus Space (mm)	Classification
HDPE Pipe 32 mm ϕ 2.9 mm wall thickness	32 mm FIREPRO® Intumescent Pipe Wrap	40 mm (W) x 2 mm (T)	4	EI 120 U/C
HDPE Pipe 40 mm ϕ 2.9 mm wall thickness	40 mm FIREPRO® Intumescent Pipe Wrap			
HDPE Pipe 50 mm ϕ 2.9 mm wall thickness	50 mm FIREPRO® Intumescent Pipe Wrap			
HDPE Pipe 200 mm ϕ 4.9 mm wall thickness	200 mm FIREPRO® Intumescent Pipe Wrap	40 mm (W) x 10 mm (T)	12	
HDPE Pipe 200 mm ϕ 11.4 mm wall thickness	200 mm FIREPRO® Intumescent Pipe Wrap			

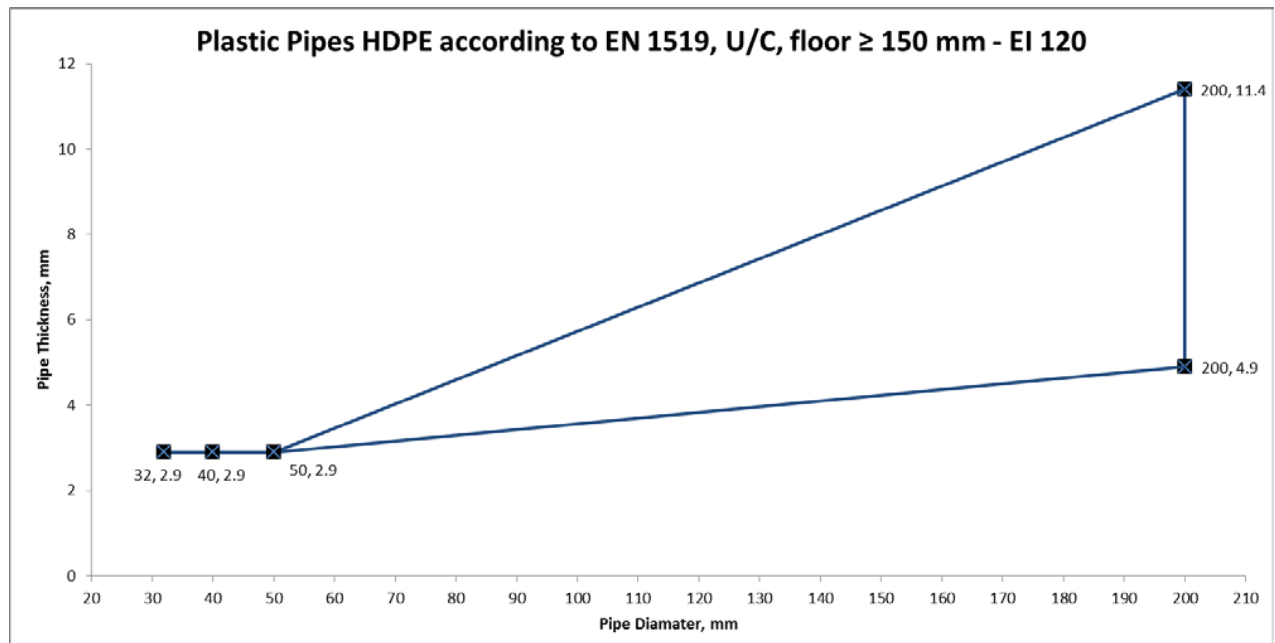

A.3 Wall construction with thickness of minimum 100 mm

A.3.1 Penetration seal with FIREPRO® Intumescent Pipe Wrap installed within both sides of flexible or rigid wall

Construction details: Combustible pipes installed with a single FIREPRO® Intumescent Pipe Wrap within both sides. Maximum annular space according to the tables listed in A.3.1.1 to A.3.1.3 filled with FIREPRO® Acoustic Intumescent Sealant.

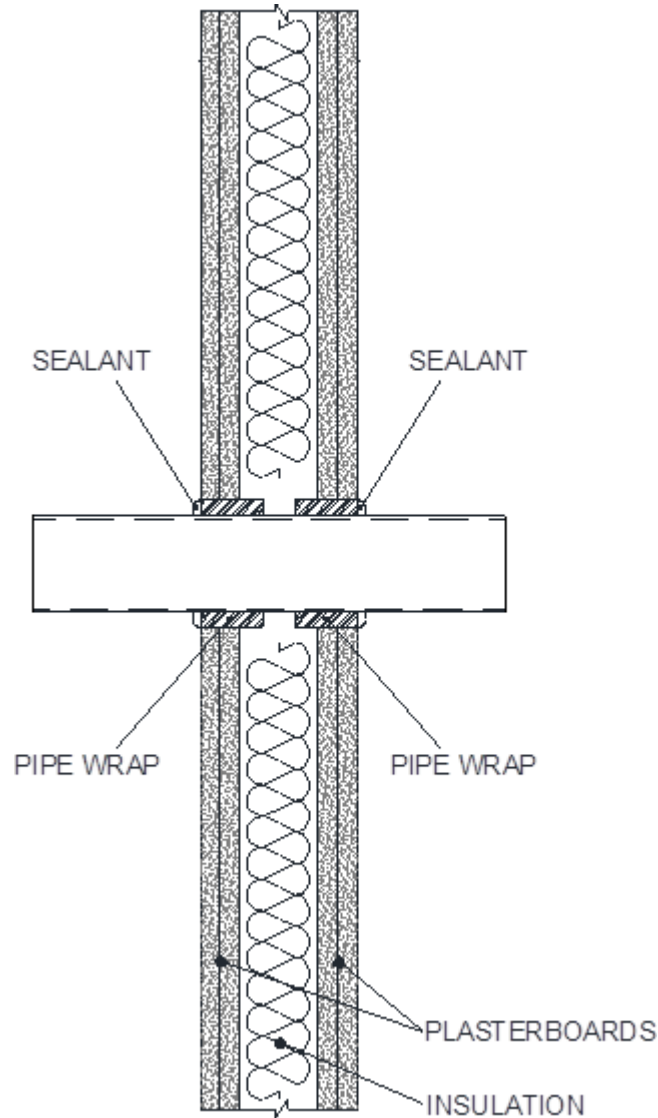

A.3.1.1 PVC-U pipes with FIREPRO® Intumescent Pipe Wrap installed within both sides of flexible or rigid wall

PVC pipes according to EN 1452 with FIREPRO® Intumescent Pipe Wrap.

FIREPRO® Intumescent Pipe Wrap, Friction Fitted Flush to Both Sides of Flexible Wall or Rigid (min 100 mm thick) PVC Pipes				
Penetration Specification	Wrap Reference	Intumescent Material	Annulus Space (mm)	Classification
PVC Pipe 32 mm ϕ 1.8 mm wall thickness	32 mm FIREPRO® Intumescent Pipe Wrap	40 mm (W) x 2 mm (T)	4	EI 120 U/C
PVC Pipe 40 mm ϕ 1.8 mm wall thickness	40 mm FIREPRO® Intumescent Pipe Wrap			
PVC Pipe 50 mm ϕ 1.8 mm wall thickness	50 mm FIREPRO® Intumescent Pipe Wrap			
PVC Pipe 160 mm ϕ 6.2 mm wall thickness	160 mm FIREPRO® Intumescent Pipe Wrap	40 mm (W) x 8 mm (T)	10	EI 90 U/C
PVC Pipe 160 mm ϕ 9.5 mm wall thickness	160 mm FIREPRO® Intumescent Pipe Wrap			EI 120 U/C
PVC Pipe 200 mm ϕ 7.7 mm wall thickness	200 mm FIREPRO® Intumescent Pipe Wrap	40 mm (W) x 10 mm (T)	12	
PVC Pipe 200 mm ϕ 9.6 mm wall thickness	200 mm FIREPRO® Intumescent Pipe Wrap			

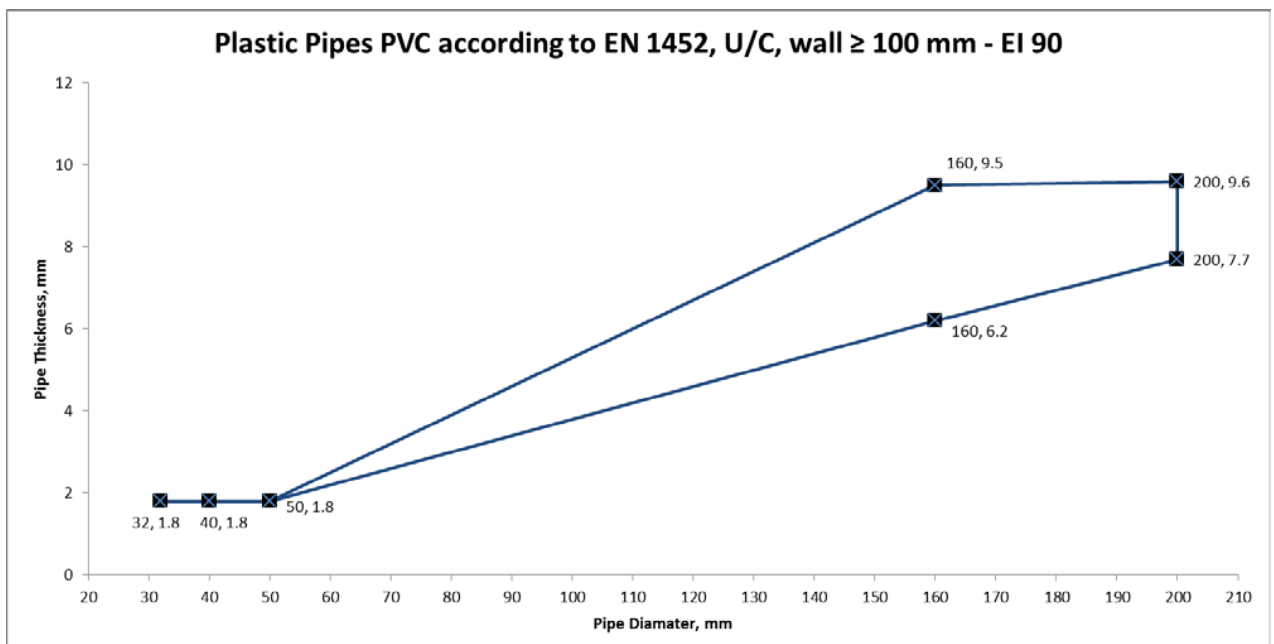

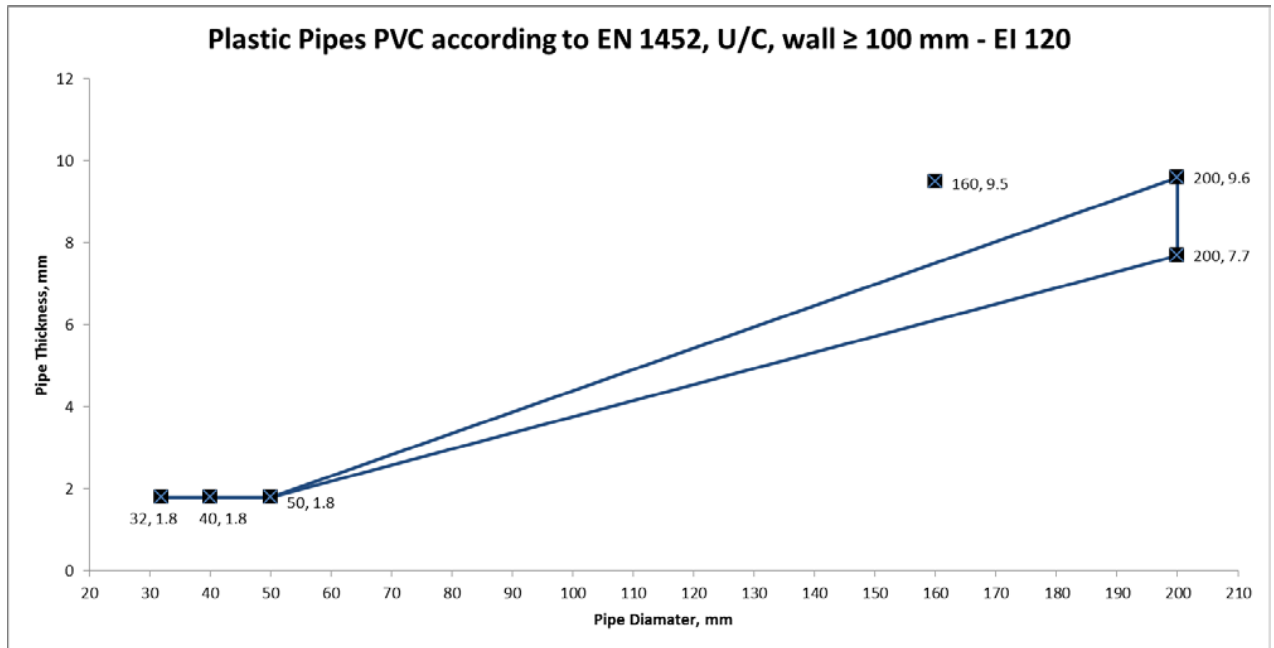

A.3.1.2 PP pipes with FIREPRO® Intumescent Pipe Wrap installed within both sides of flexible or rigid wall

PP pipes according to EN 1451 with FIREPRO® Intumescent Pipe Wrap.

FIREPRO® Intumescent Pipe Wrap, Friction Fitted Flush to Both Sides of Flexible Wall or Rigid (min 100 mm thick) PP Pipes				
Penetration Specification	Wrap Reference	Intumescent Material	Annulus Space (mm)	Classification
PP Pipe 32 mm \varnothing 2.9 mm wall thickness	32 mm FIREPRO® Intumescent Pipe Wrap	40 mm (W) x 2 mm (T)	4	EI 120 U/C
PP Pipe 40 mm \varnothing 2.9 mm wall thickness	40 mm FIREPRO® Intumescent Pipe Wrap			
PP Pipe 50 mm \varnothing 2.9 mm wall thickness	50 mm FIREPRO® Intumescent Pipe Wrap			
PP Pipe 160 mm \varnothing 4.0 mm wall thickness	160 mm FIREPRO® Intumescent Pipe Wrap	40 mm (W) x 8 mm (T)	10	E 120 U/C EI 90 U/C
PP Pipe 160 mm \varnothing 14.6 mm wall thickness	160 mm FIREPRO® Intumescent Pipe Wrap			EI 120 U/C
PP Pipe 200 mm \varnothing 4.9 mm wall thickness	200 mm FIREPRO® Intumescent Pipe Wrap	40 mm (W) x 10 mm (T)	12	E 120 U/C EI 90 U/C
PP Pipe 200 mm \varnothing 18.2 mm wall thickness	200 mm FIREPRO® Intumescent Pipe Wrap			EI 120 U/C
PP Pipe 250 mm \varnothing 10.1 mm wall thickness	250 mm FIREPRO® Intumescent Pipe Wrap	40 mm (W) x 12 mm (T)	14	E 120 U/C EI 20 U/C

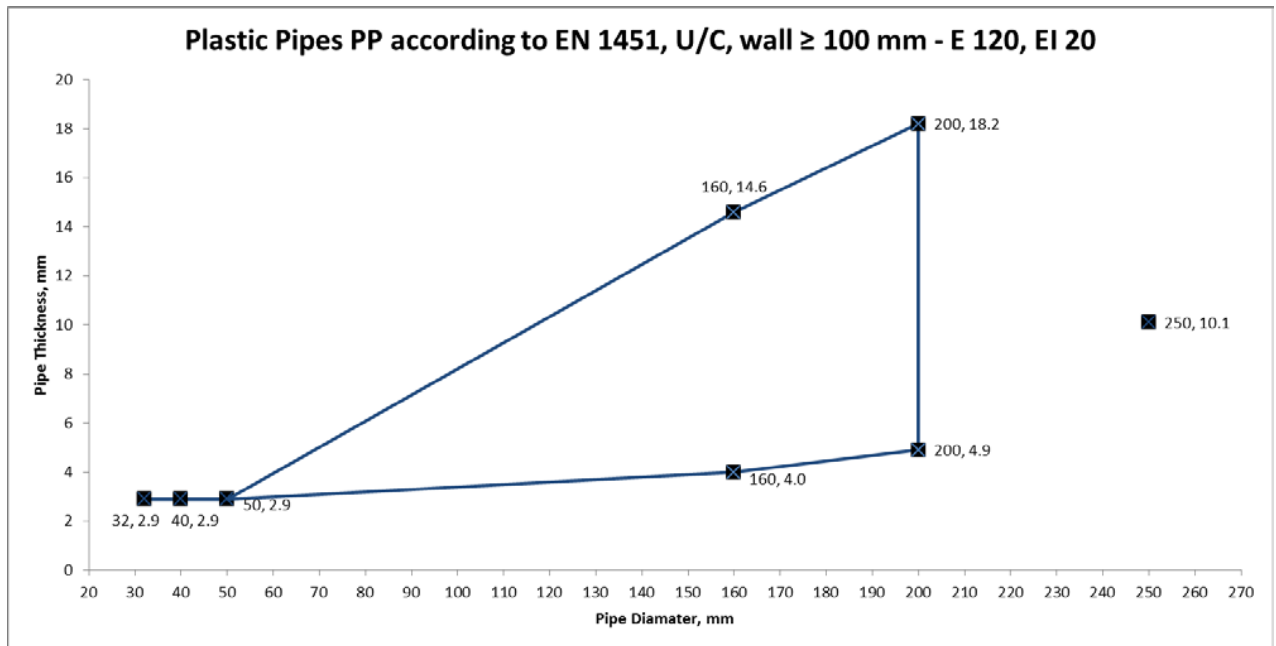

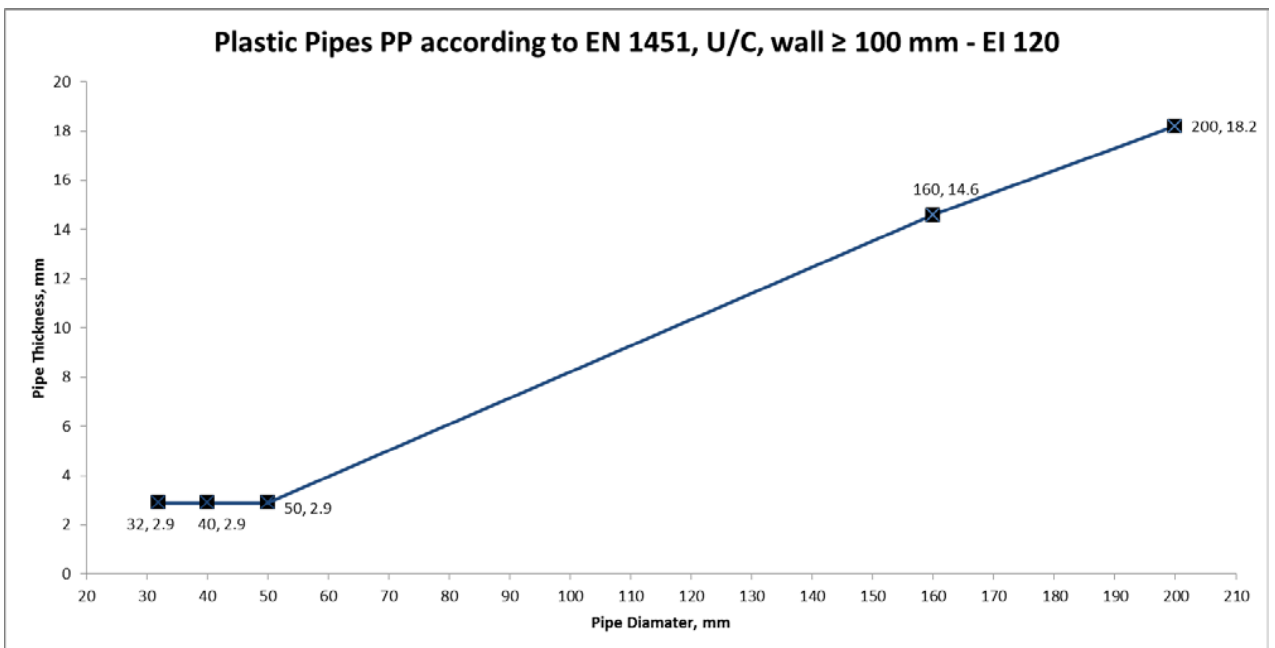
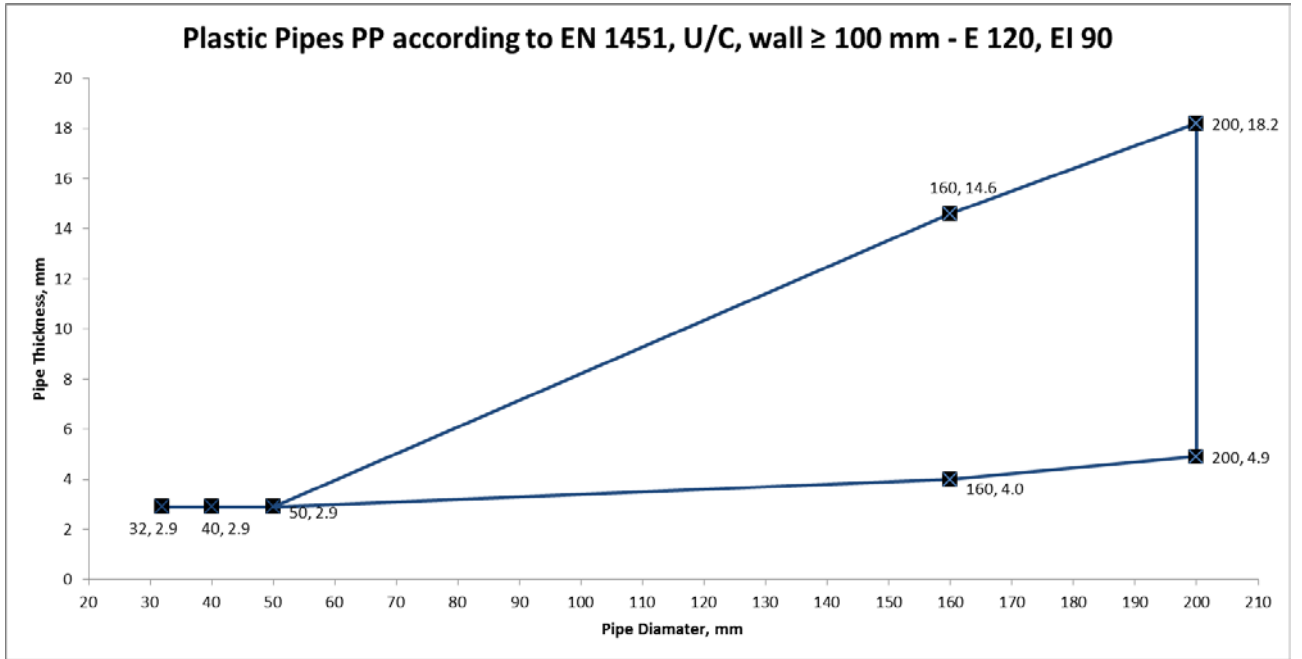

A.3.1.3 PE pipes with FIREPRO® Intumescent Pipe Wrap installed within both sides of flexible or rigid wall

PE pipes according to EN ISO 15494 with FIREPRO® Intumescent Pipe Wrap.

FIREPRO® Intumescent Pipe Wrap, Friction Fitted Flush to Both Sides of Flexible Wall or Rigid (min 100 mm thick) PE Pipes				
Penetration Specification	Wrap Reference	Intumescent Material	Annulus Space (mm)	Classification
PE Pipe 32 mm ϕ 2.9 mm wall thickness	32 mm FIREPRO® Intumescent Pipe Wrap	40 mm (W) x 2 mm (T)	4	EI 120 U/C
PE Pipe 40 mm ϕ 2.9 mm wall thickness	40 mm FIREPRO® Intumescent Pipe Wrap			
PE Pipe 50 mm ϕ 2.9 mm wall thickness	50 mm FIREPRO® Intumescent Pipe Wrap			
PE Pipe 160 mm ϕ 4.9 mm wall thickness	160 mm FIREPRO® Intumescent Pipe Wrap	40 mm (W) x 8 mm (T)	10	EI 15 U/C
PE Pipe 160 mm ϕ 9.5 mm wall thickness	160 mm FIREPRO® Intumescent Pipe Wrap			EI 90 U/C
PE Pipe 200 mm ϕ 4.9 mm wall thickness	200 mm FIREPRO® Intumescent Pipe Wrap	40 mm (W) x 10 mm (T)	12	EI 15 U/C
PE Pipe 200 mm ϕ 18.4 mm wall thickness	200 mm FIREPRO® Intumescent Pipe Wrap			EI 120 U/C

